

An Overview of Seismic Damage Mitigation for Museums

Jerry Podany

Senior Conservator of Antiquities, J. Paul Getty Museum, Los Angeles, California

This paper will present an overview of the developments and methodologies used for the mitigation of earthquake damage to museum collections as illustrated by case studies at the J Paul Getty Museum in Los Angeles California.

Our present understanding of earthquakes comes from a large body of geophysical research and empirical observation. The characterization of the response of sites and buildings to strong ground motions due to fault ruptures has led to significant advancements in the area of seismic engineering. Primary among the driving forces for these advancements have been concerns about life safety and financial loss, and the necessity that essential services such as hospitals, basic utilities, and security services show resilience and continue to function despite the disruptive effects of earthquakes.

A smaller (though growing) body of research has focused on the response of non-structural elements and contents to both ground motion and building response (Zhu and Soong 1998, Hutchinson et al 2010 and ATC 1998). Nonstructural elements are generally described as those components (including contents) that are not part of the structural integrity of the building (examples include façades, architectural elements, nonstructural walls, hung ceilings, plumbing systems, HVAC systems, machinery, and other free standing equipment). In most cases the mitigation of damage to such nonstructural elements is a matter of economic concern, although life safety issues and the continuation of essential services also play a role.

An even smaller, and certainly inadequate, body of research exists regarding the effects of strong ground motion on heritage collections in museums (including fine art museums, anthropological collections,

science and technology collections, history museums, archives and storage facilities). For the purpose of this discussion such collections can be considered *contents*. This paucity of information and the lack of the development of mitigation approaches related to heritage collections persist despite the value (both monetary and cultural) of these collections and, in some cases, the clear potential for parts of these collections to present life safety concerns during seismic events (threats posed by overturning monumental sculpture and archive “stacks” and the possibility of chemical spills in natural history or science museums for example).

Interestingly, while cultural heritage collections have, for the most part, not been included in seismic mitigation studies, historic structures have been included, though to a comparatively limited degree. Historic built structures have gained attention because they relate directly to the major focus of most seismic engineering studies and present within those interests unique challenges. After all, although historic structures are built with material and methods no longer in common use, they respond to ground motions in reasonably similar ways to that of most recently built structures. And of course, life safety issues apply to historic structures that are in use in the same way as they do to modern structures. It might also be said that when damage occurs to historic structures it is more apparent than damage to collections, which is often not disclosed and is less accessible to the public at large.

Although the study of the response of collections to earthquake-induced forces relates directly to the research on nonstructural elements, such as hospital equipment or transformers, works of art and historic artefacts present significantly greater challenges to mitigation efforts due to their relatively small mass, fragility, unknown material characteristics, and complex history. The unknown factors due to systemic uncertainty multiply quickly.

Additionally, the employment of mitigation approaches to collections is governed by a series of ethical preservation tenets and aesthetic considerations not necessarily of concern in industrial and commercial situations. Modern guidelines within heritage conservation, which reflect concerns of authenticity and desires for material-based preservation, dictate that, as much as possible, the work of art or the historic

artefact should be left unaltered by the mitigation approach and that any addition should be non-intrusive to the fabric of the object and completely reversible. While this cannot always be achieved it is always strived for. Aesthetics play an equally important role, especially in museums. The mitigation efforts must not detract from the visual presentation of the object. In general, then, cultural objects present unique and difficult challenges for engineers, conservators, and mount makers. Inevitably a conflict arises between risk reduction and aesthetic presentation which, for the sake of long term preservation, must be overcome.

For over four decades the J. Paul Getty Museum has researched these issues and developed techniques for the protection of its collections from earthquake damage (Podany 1992, 1996, 2008). The process has followed a well-established route:

- Determination of the degree of tolerable risk to the collection
- Identification and characterization of the hazard
- Estimation of the probable response and ground motion at the site of interest
- Characterization of the building response to the ground motion
- Characterization, in general terms, of the response of the objects, taking into account the variety of their forms, material characteristics, location within the building, and display/storage conditions
- Development of methods for risk management, risk reduction, and damage mitigation
- Implementation, regular review, and update of those methods

By necessity, these various steps require an extended multidisciplinary effort involving seismologists, seismic engineers, geologists, structural engineers, mount makers, technicians, and conservators as well as designers and curators supported by directors and administrators to find the best and most sustainable ways of protecting collections. It is not an easy task since the various professionals bring to the effort quite different backgrounds, varying levels of understanding, and a diverse set of concerns. It might even

be said that they speak different professional languages. It is likely that heritage collection professionals (curators, registrars, conservators, mount makers, collection managers, etc.) do not have the background to readily and fully understand the concepts that underlie statements made by engineers. Nor is it likely that engineers will have a full grasp of the concerns and approaches held by collections professionals regarding the preservation and exhibition of collections. It is often the task of the conservator or collections care professional to act as a conduit between the two groups.

The range of professionals that make up the hazard and risk management “team” will almost certainly speak different professional languages and nothing demonstrates this more fully than the first step in seismic hazard analysis: the probabilistic estimation of the earthquake threat to a specific location and a specific collection. Probabilistic seismic hazard analysis involves complex statistical approaches that are, generally speaking, foreign to most collections professionals. Such professionals are not trained to consider percentages of acceptable loss or the investment of resources to mitigate risks that might only be realized in time frames measured in hundreds of years. And yet if the inevitable hazard is not addressed whole collections can be lost.

For these reasons it is evident that seismic damage mitigation represents the cutting edge of multidisciplinary preventive conservation and long-term preservation efforts.

The Getty Museum began this first step in 1984 when the firm of Lindvall Richter and Associates (LRA) was contracted to complete a site and building study to determine the worst case scenario seismic event at a risk level acceptable to the museum. The museum director and professional staff, after long discussions with LRA engineers, designated the acceptable risk level as a seismic event with an 80% probability of NOT being exceeded during a 50 year period (a recurrence rate of approximately once in 225 years). At that time there were no guidelines as to what was considered a tolerable risk level for museum collections (a situation that unfortunately remains generally true today) and so the chosen level was influenced by both a sense of conservatism and the standard life expectancy of the museum structure.

Following well-developed protocols for the time (historic seismicity, geological information, and seismological studies) it was determined that, for the risk level established by the museum, a magnitude 8.3 earthquake on the San Andreas Fault system (at a distance of 42 miles or 74 km) lasting approximately 60 seconds and a magnitude 6.5 earthquake on the Malibu Coast-Santa Monica system (a distance of 1 mile or 1.6 km from the museum site) lasting approximately 20 seconds, were the most likely source candidates. The study postulated that such events would result in, respectively, a 0.2 g and 0.7 g horizontal site ground motion and an estimated 0.1 and 0.45 vertical acceleration (Figure 1).

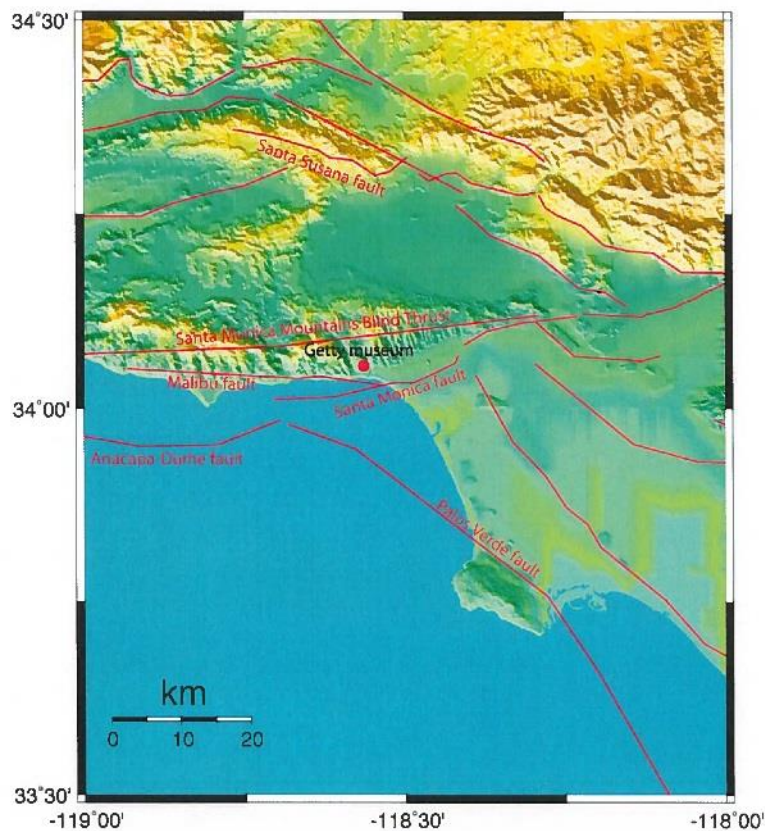

Figure 1: Major fault systems in proximity to the Getty Museum. Source: "Ground Motion Response Spectra and Time Histories, Getty Museum, Malibu" URS, 2005. Internal report.

Using a detailed mathematical model of the main museum building the engineers determined that the structure demonstrated significant stiffness, with the fundamental period close to 0.1 seconds. This short period was likely due to the dominance of shear walls in the museum structure, its configuration and the thickness of the museum walls. The mathematical model was subjected to earthquake time histories which included a magnitude 6.5 earthquake on the Malibu Coast-Santa Monica fault system. Due to the high stiffness of the building it was expected that the free-field dynamic motions would not be significantly magnified on the second floor of the structure (the museum is a two-story building).

In 2005 the Getty contracted URS Corp to update the LRA study in preparation for a major renovation of the structure which included stiffening of the floors on the second story with carbon fiber composite mats, the installation of a steel beam system in the walls to support heavy works that would be wall hung, and the installation of regularly spaced floor anchors for display furniture and object/furniture systems. The URS study (URS 2005) incorporated probabilistic seismic hazard analysis methodology and more recent developments in the field of seismology such as pulse rupture directivity pulse effects published extensively by Somerville (1997, 2003). A 50% in 50 year probability (72 year return period) and a 10% in 50 year probability (475 year return period), both evaluated for 5% and 15% damping, were used. Figures 2 and 3 show the equal hazard spectra for 5% and 15% damping, including pulse directivity data. The directivity data can be seen to only minimally increase the amplitude for longer periods but to dramatically increase displacement in the fault normal direction for the 5% damping value.

Although the 2005 URS study enhanced the Museum's understanding of the specific hazards that threaten the museum site, the findings did not significantly differ from the earlier LRA report and the Museum has retained the use of its design time histories for design and testing of mitigation measures.

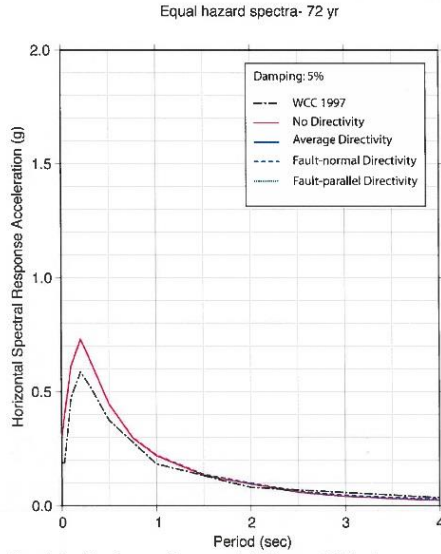

Figure 3a. Equal hazard spectrum for a return period of 72 years and 5% damping.

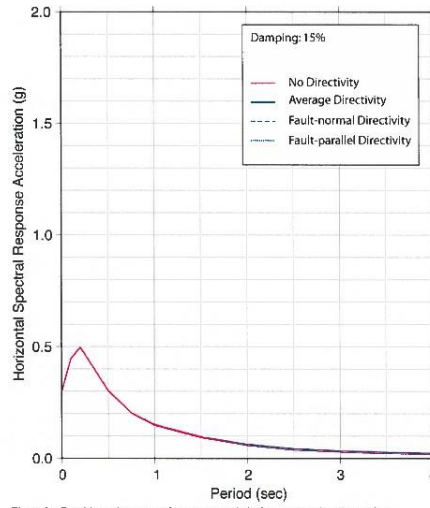

Figure 3c. Equal hazard spectrum for a return period of 72 years and 15% damping.

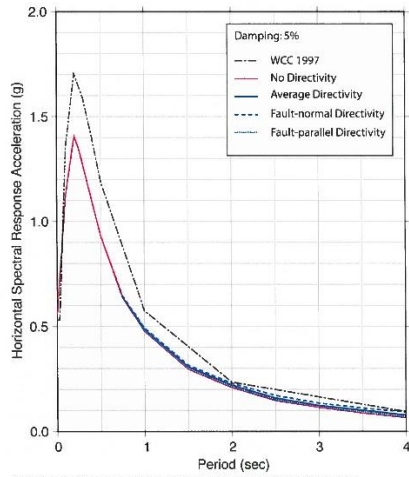

Figure 3b. Equal hazard spectra for a return period of 475 years and 5% damping.

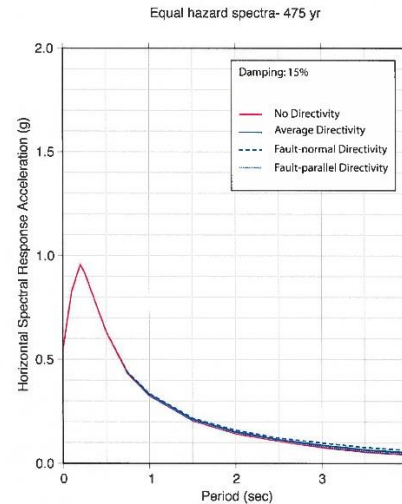

Figure 3d. Equal hazard spectra for a return period of 475 years and 15% damping.

Figure 2: Equal hazard spectra for 72 yr. and 475 yr. return periods with 5% and 15% damping. Note that WCC is the 1997 Woodward-Clyde Consultants results, which differ due to the use of alternate attenuation relations and recurrence models. Source: "Ground Motion Response Spectra and Time Histories, Getty Museum, Malibu" URS, 2005. Internal report.

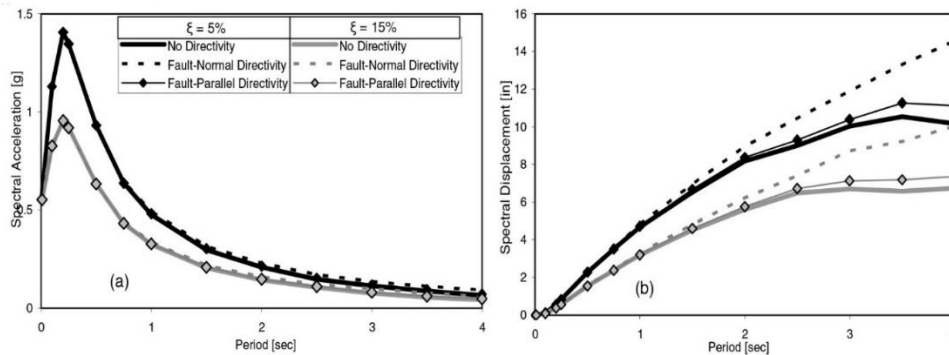

Figure 3: Equal hazard spectra for a return period of 475 years at 5% and 15% damping a. acceleration and b. displacement.

As a result of the above findings the design time history developed for the site was also used to evaluate the response of objects, independent of their placement in the building. However the location of floor support beams was considered in the evaluation of vertical response (Figure 4).

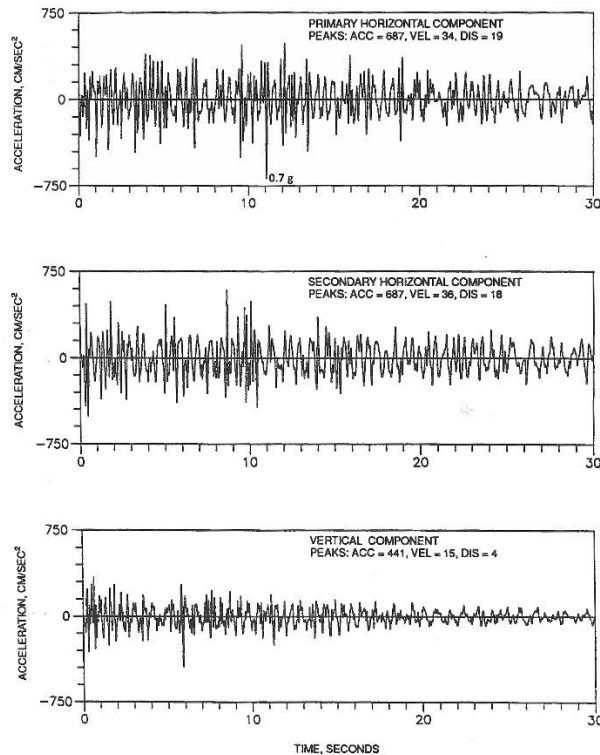

Figure 4: representative design time histories for the Getty Museum in Malibu.

Soon after the 1985 LRA report, the Department of Antiquities Conservation began working with LRA engineers, the Museum Preparations Department, and the curators and exhibition designers to survey the collection. The Getty Conservation Institute commissioned Prof. M.S. Agbabian, Prof. S.F. Masri and Prof. R. L. Nigbor (all of the Department of Civil Engineering at the University of Southern California, Los Angeles) to undertake a study of object response to strong ground motion using a predominantly static response approach (Agbabian et al. 1990). The basic approaches put forward in that report have continued to be used within the Museum.

Object response: Four basic modes of response were identified for rigid masses of consistent density. These were based on static analyses first postulated by West in 1882 (Figure 5) and introduced by John Milne (1885), Housner (1963), Ishyama (1984), Zhu and Soong (1998) Hutchinson et al , (2010), and Kafle (2011).

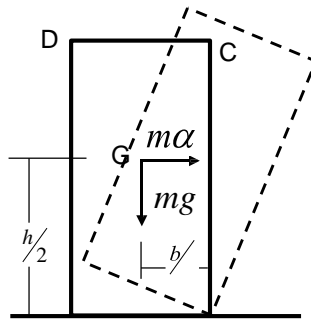

Figure 5: West 1882 formula as published by Milne in 1885.

As illustrated in Figure 6, these responses are:

1. **Stability** (which indicated that the mass would translate with the ground)
2. **Sliding** (which would occur when the forces acting on the center of gravity were greater than the inertial forces, and the coefficient of friction between the bottom face of the object and the supporting ground was sufficiently low to allow for translation)
3. **Rocking** (when the force acting on the center of mass of the object was greater than the base-to-height ratio of an object's equivalent block and the coefficient of friction was sufficiently high to resist sliding)
4. **Overturning** (when the forces acting on the center of gravity were such that the center of gravity extended beyond the defined boundaries of the base dimension or footprint and the coefficient of friction was sufficiently high to resist sliding)
5. **Combination** of 2, 3 and 4

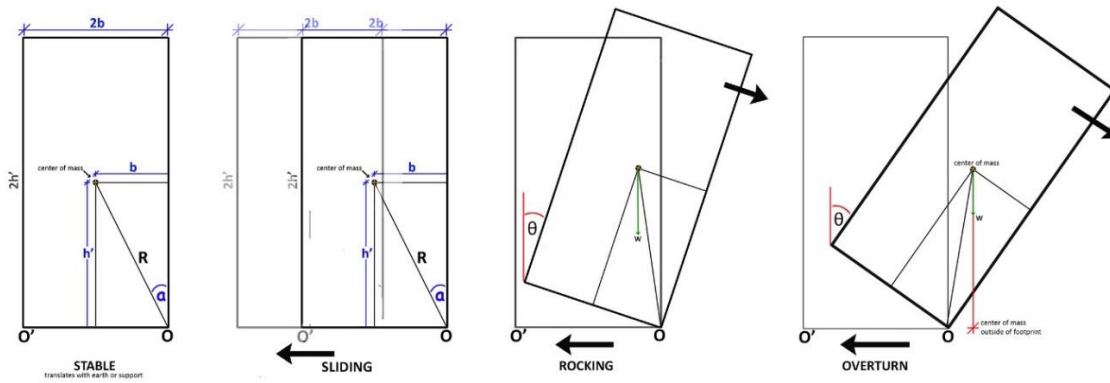

Figure 6: Four possible responses of rigid mass of consistent density (not including full uplift).

To evaluate which of these four basic categories, or combinations thereof, an object or object/furniture assembly might fall into, the Museum uses a multi-component approach to calculate the equivalent block. Figure 7 shows the calculation of two simple shapes with a variation in mass distribution for each. Note that making part of the model heavier, by assigning a more dense material, lowers the center of mass.

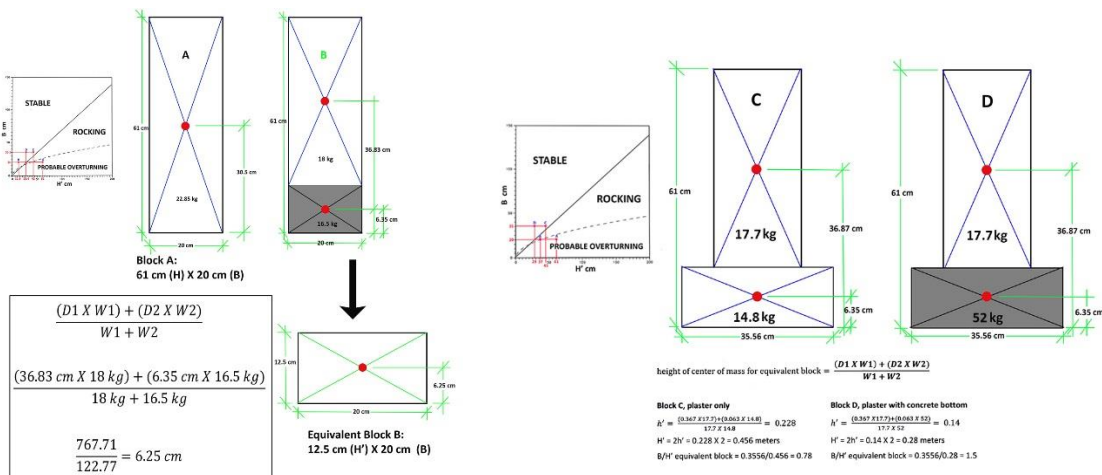

Figure 7: calculations of the equivalent block for a simple shape.

This approach is applied to more complex volumes and sculptures as illustrated in Figure 8. The sculpture is first divided into geometric components whose individual centers of mass are determined. The equivalent block is then calculated and the object's stability or response is generally determined.

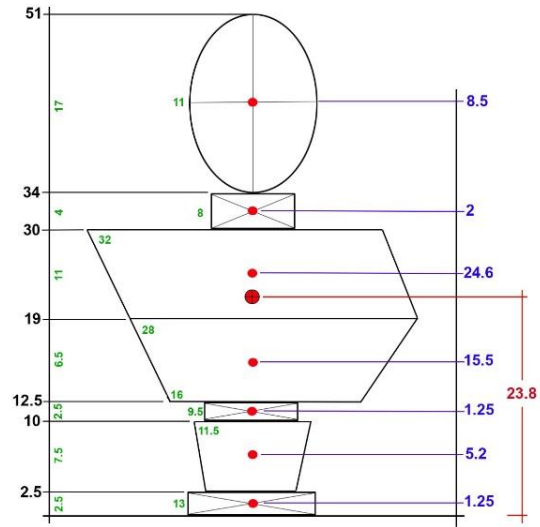

Figure 8: a sculpted bust reduced to 6 geometric component masses and then the total center of mass is calculated.

Within the last several years the Getty Museum has been increasingly utilizing digital scanners to model objects and the using simple finite element programs to calculate, with greater precision, the coordinates of the center of mass, Figure 9.

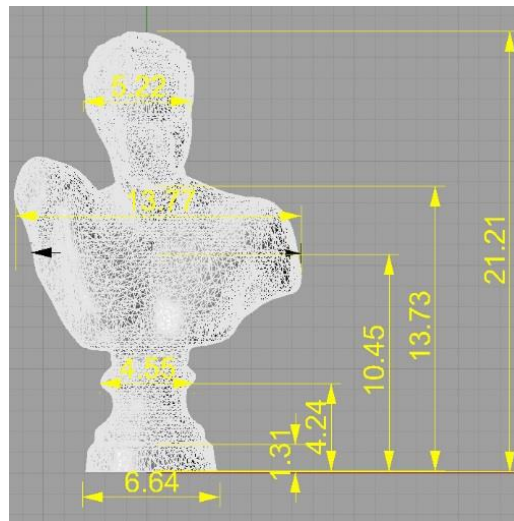

Figure 9: the same object as depicted graphically in figure but in the form of a digital scan. Note the center of mass is located slightly higher--26.7 cm (10.45 inches) rather than 23.8 cm--due to greater accuracy of mass distribution.

Damage mitigation: Seismic damage mitigation undertaken by the Getty Museum falls into two broad categories termed *passive* and *dynamic*. The *dynamic* category involves the use of controlled sliding and isolation bases. These will be described later in this paper.

The *passive* methods involve altering the mass distribution of the object by adding weight to the object or securing the object to an additional mass to effectively lower the assembly's center of mass to the extent that the object is stable during the design earthquake input. This is shown in Figure 10, which generally characterizes a variety of approaches applied, for the sake of illustration, to one object.

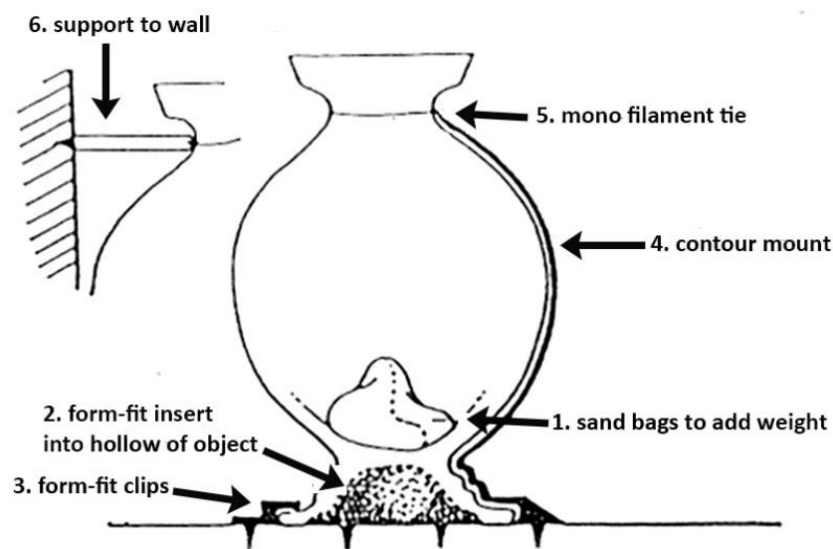

Figure 10. A variety of passive mounts illustrated using one object, a vase.

The illustration uses a hollow ceramic vase. Number 1 illustrates the addition of weight to the object in order to lower its center of gravity. In this case it is done by a cloth bag filled with sand. If such an approach is used caution should be exercised to assure that the structural integrity of the object can support additional weight. The possibility of sliding and rocking should be considered. It should also be kept in mind that it may require significant weight to lower the center of gravity sufficiently to result in full stability. Approach 2 shows a form-fit insert (made of dense foam or hard synthetic material covered with a protective fabric), that is anchored to the exhibition deck. If the object has a depression or hollow

at its lower face such inserts can prevent sliding and, if sufficiently deep, can assist in resisting uplift/rocking. Illustration 3 shows the use of form-fit metal clips which, in this case, hold the vase down along the rim of its foot. These clips should be padded where they are in contact with the object's surface and contoured to fit intimately to the shape of the object. Several clips should be used to distribute the restraint and to avoid point loading. Great caution must be taken to assure that the material strength of the object is sufficient to withstand the concentration of stresses at the clip locations during an earthquake. An alternate to such clips is the use of wax to secure the object to a display surface. Wax is applied in small amounts at distributed locations over the bottom surface of the object and then gently pressed down onto the supporting surface. Caution should be exercised when applying the wax since porous surfaces might be stained or the wax may ingrain itself into recesses and be difficult to remove. Surfaces of objects can be locally coated with an acrylic resin in those areas where the wax is applied to prevent this problem. Removal can also carry significant risks since the shear load that must be applied (in a rotation, torque) to break the bond of the wax can be significant. Additionally the strength of such wax-to-object and wax-to-support surfaces is difficult to calculate and control. If objects are relatively heavy and/or have a high center of gravity wax bonds are most likely not an effective anchoring method. Number 4 illustrates the use of a "contour mount" (Figure 11). Such a mount is best made of a stiff metal like stainless steel which has been bent to intimately follow the contour of the object. The lower end of the mount is anchored securely to the display deck. The object is secured to the mount at strategic points along the length of the mount using a sufficiently strong monofilament. Synthetic felt should be used where the contour mount is in contact with the object. The purpose of the contour mount is to restrict the movement of the object while also providing additional stiffness. Care should be taken to assure that the rotation of the object is also restrained. This can be done by the addition of horizontal contour arms attached to the vertical contour mount or by combining the contour mount with an insert. Number 5 illustrates a method to restrain the object from movement by anchoring various parts of the object to a wall or exhibition case back (Figure 12). An extension from the back of the exhibition case or wall protrudes to meet an appropriate point on the vase where the vase is secured to the restraint with

monofilament. In such an instance the bottom of the object should also be restrained using one of the methods described.



Figure 11: Three examples of contour mounts.



Figure 12: A static mount that secures the assembly of a multi-part vase to the deck the vase base) and the back wall of an exhibition case (the foot of the vase).

In most cases passive mounts assume that the object is sufficiently robust to survive the transmitted forces generated by the building's response to the earthquake. Passive mounts restrain the object's motion and can add stiffness and strength to the object assembly. While the design and application of such passive mounts can be highly effective and cost-efficient, caution must be exercised to assure their appropriate use. The susceptibility and fragility of the object under consideration must be fully characterized. For larger objects, the efficiency and strength of the anchor is also of great importance. A safety factor of three is recommended. Additionally, fully anchored objects or object/furniture systems will exhibit unique natural periods. These should be measured to determine whether or not potential amplification due to resonance might occur during an earthquake. For example, Figure 13 shows an object and its natural period. The natural period was determined to be approximately 0.27 seconds. Given the response spectra this is an area of significant intensity of ground motion for the Getty site and therefore this object was evaluated to determine if it was sufficiently robust to withstand a possible harmonic amplification.

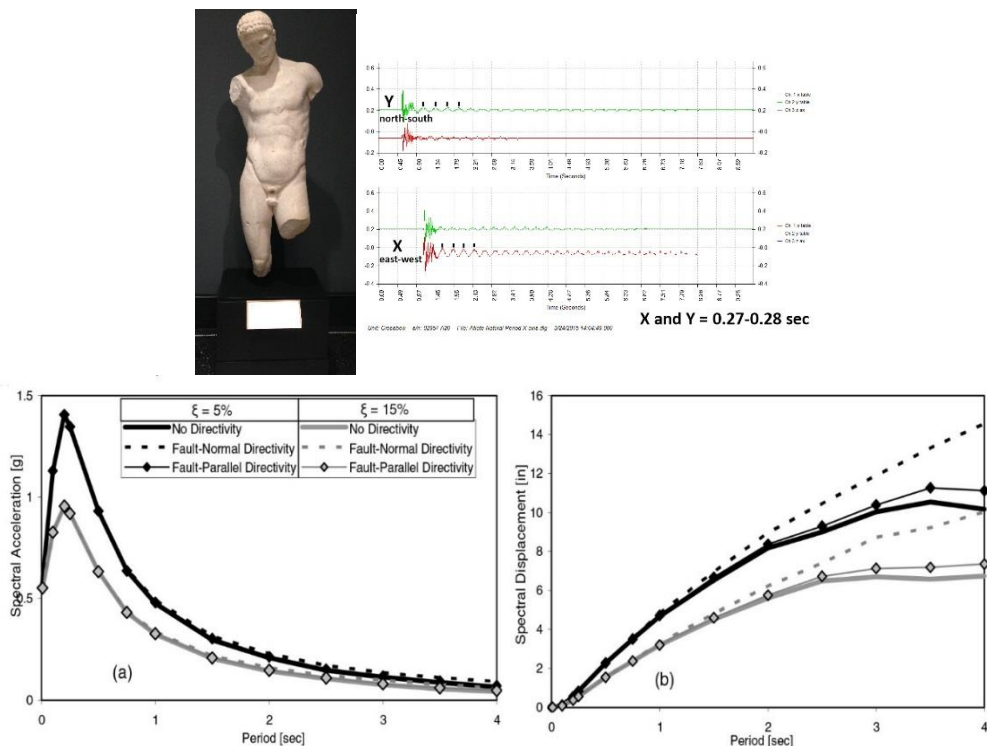

Figure 13: A life-size sculpture with a natural period of between 0.27 and 0.28 seconds and the related response spectra for the Getty Museum site.

The mount makers at the Getty Museum (Department of Antiquities Conservation, McKenzie Lowry and B. J. Farrar) have designed and implemented a number of ingenious methods to secure objects to exhibition furniture while minimizing any intrusion upon the fabric of the object itself. For example, two life-size marble figures were on loan to the Getty Museum for a special exhibition. Although they were basic pillar shaped masses, the center of mass of each was relatively high, and each of their foot prints was small and had an uneven surface on the underside of its base (essentially the two objects were somewhat unstable). No pins or anchoring devices had been introduced into the bottoms of the objects and none was allowed. Still, the objects had to be stabilized and anchored for safe display. A compression anchoring system was designed and built into the exhibition pedestal by the mount makers to capture and secure the objects to a display pedestal for exhibition (Figure 14 and 15).

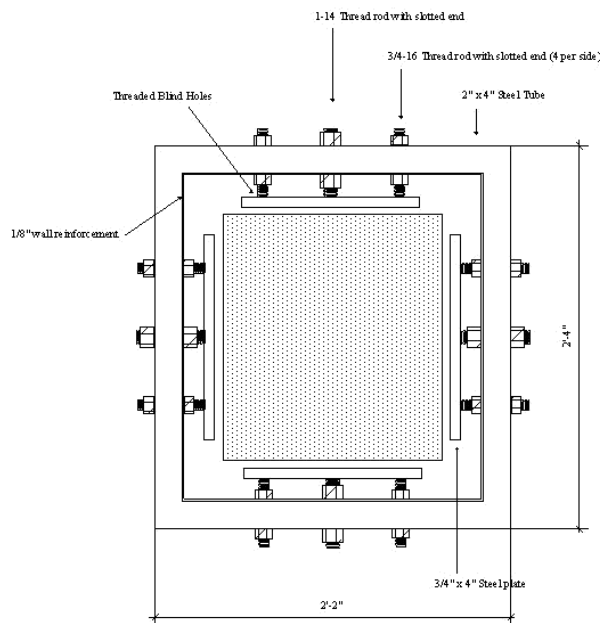

Figure 14: a schematic and a top view of the compression mount which was designed and built to secure two life size marble sculptures

Each of the standing marble sculptures had an integral base segment, the sides of which were captured by custom clamp plates. These clamp plates were cast to intimately fit the contours and topography of the sides of the base. Sufficient compression was applied to the plates to securely hold the sculpture in place. Test models which replicated the surfaces and distribution of mass indicated that the sculptures would be securely held in place even when loads reached one full g force.



Figure 15: the installed sculptures (without the base cladding) and a side view of the compression mount/pedestal.

Dynamic mitigation: The second general category of mitigation involves a form of *decoupling* of the object or object /assembly from the ground. This can be achieved by lowering the coefficient of friction between the bottom face of the object or object/assembly and the floor, allowing sliding to occur. For a limited number of instances, particularly when a relatively large platform supports a group of objects or a single monumental object, and the base-to-height ratio is high (center of mass is low) and favorable to stability (defined in this case by no uplift or rocking) it is possible to allow sliding if the surrounding area, including the surface on which the sliding occurs, is clear of obstructions within the distances that would

accommodate the estimated ground displacements. Sliding has been implemented at the Getty Museum in a limited number of cases by the installation of Teflon® pads to the bottoms of the pedestals, cases or platforms on which the objects are affixed. Caution should be exercised, however, in assuring that the floor or surface on which the assembly slides is smooth and free of any ridges, depressions or sudden shifts in roughness and that there are no structural or non-structural masses which the object being protected might collide with.

Base isolation: The use of base isolation results in the reduction of inertia forces that can act on the structure, equipment, and objects or object/furniture systems in collections. Although predominantly used in the protection of buildings, bridges, or other built structures, base isolators are gaining popularity in the protection of non-structural elements and contents within buildings (such as medical equipment, or computer facilities for example). Essentially a base isolator lowers the frequency or the natural period of an entire system or single object. The goal is to alter the natural period of the system or object so that it lies as far away from the range of periods that are shown by response spectra of the site or building as having the greatest acceleration demands, as shown in Figure 16. In many cases this means that the displacement demands will increase and the base isolator must either accommodate these large displacements or the system must be able to withstand the forces resulting from a shorter period of isolation or the forces induced by the sudden stop of displacement.

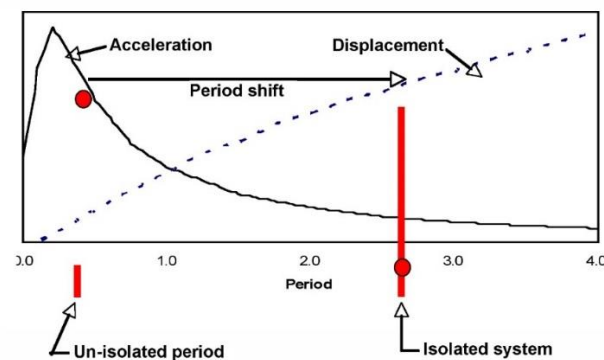

Figure 16: The isolated system shows a shift from a short period, where the response spectra shows significant amplitude, to a longer period where amplitude is much lower but displacement is much greater. From Schoettler and Stavridis 2009

More controlled displacements can be accomplished through base isolation which is achieved in a variety of ways including visco elastic columns, roller bearings and Teflon-coated spherical sliding bearings. Rigid objects, commonly damaged by the high acceleration characteristics of many earthquakes, despite the low displacements, are protected from damage by isolation mechanisms which provide the object/isolator system with a longer period. Flexible objects, however, can suffer significant deformation if exposed to large displacements and thus isolators which are intended to protect flexible objects must provide sufficient displacement capacity to accommodate the larger periods. The design and *tuning* of any isolator design must take into account the source-to-site distance, local site conditions, and the system's damping contribution.

The design of the first base isolator to be used at the Getty Museum was designed by Quantec Systems of California in 1985 under contract with the Museum. It was designed for a specific sculpture which had been assembled from fragments using a version of post tensioning to secure the fragments together and then to secure the sculpture to an exhibition pedestal. The basic concept of the isolator was similar in many ways to a variety of ball and cone, inverted pendulum, and friction pendulum systems used in buildings, bridges and other structures all around the world. The basic concept was first developed by D. A. Stevenson around 1867 (Stevenson 1881) for the protection of light house apparatus (Figure 17 and 18) and for structures by Touaillon in 1870 (Chong-Shien 2012) .

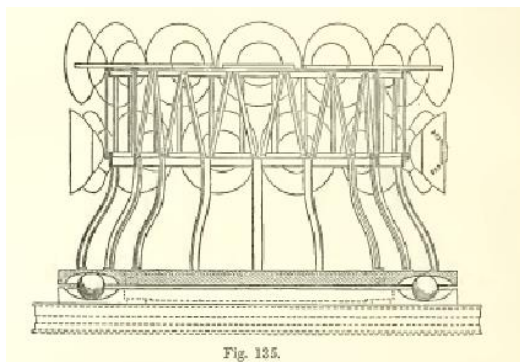

Figure 17: An isolation base for lighthouse reflectors designed and manufactured by D.A. Stevenson in 1867. From (Stevenson 18810. The same approach would then soon be attempted on entire structures.

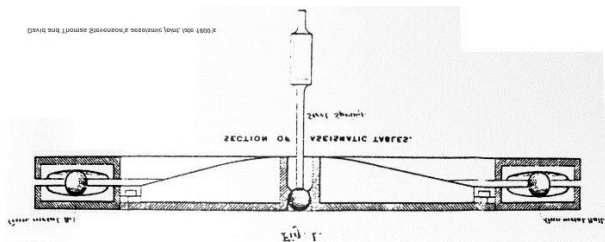

Figure 18: At a later date Stevenson added a type of spring steel centering mechanism.

In the case of the Quantec design, however, a flat circular steel plate sat on the floor and affixed to its center point was a vertical, collapsible spring-loaded column terminating in a ball bearing. A large and heavy base supported by regularly spaced captured ball bearings sat on the plate. The underside of the base had a concave dome-shaped hollow. As the base displaced relative to the floor plate, the curvature of the dome caused the central ball bearing shaft to compress, providing an increased resistance to displacement and a restoring force to the overall base isolation mechanism (Figure 19). Somewhat similar isolation mechanisms were also evaluated for the museum's showcases, but were ultimately replaced.

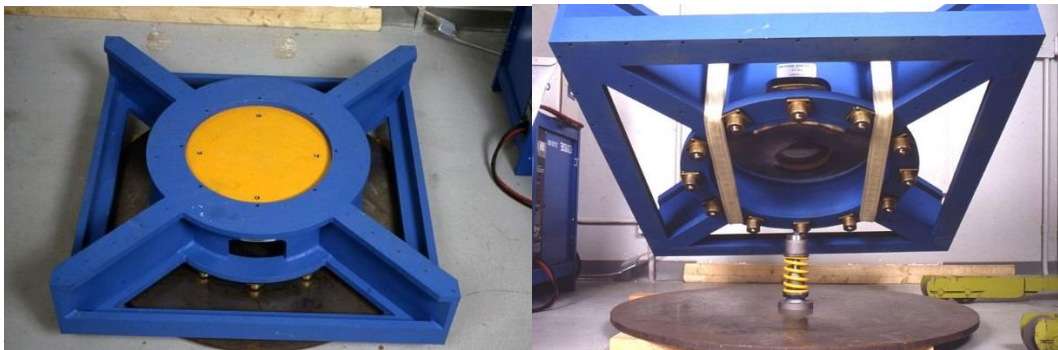

Figure 19: Quantec isolation base upper surface and underside view

Concern increased within the museum however regarding large displacements, even at low accelerations, and especially large vertical forces that could negatively affect isolator designs that were free to uplift. The Northridge earthquake of 1994 recorded free field vertical accelerations of up to 85% g (Mahin 1988) and led the museum to further develop its own isolation mechanism which eliminated the possibility of vertical uplift and resultant impact forces (single or multiple) in a major event.

The base isolation mechanisms designed and used at the Getty Museum consist of three metal frames stacked upon one another with the capability of displacing into uncoupled perpendicular directions. The restoring force is provided by compression springs situated between two adjacent frames (Figure 20).

The springs are installed in parallel on guide rods at each of the two levels. As the frames displace, a roller block travels along a curved interior edge of the frame for each level, compressing the spring set and thus increasing the resistance to displacement and providing a returning force. The middle frame slides over the bottom frame (which is rigidly attached to the floor) along two adjacent rails via trapped bearing blocks. The top frame slides over the middle frame via identical parallel rails and trapped bearing blocks. In this way the middle and top frame displace horizontally but the entire system is restricted from any vertical uplift. Exhibition furniture or objects are rigidly attached to the upper frame. In an exhibition environment the base isolator is hidden under cabinetry facings, the sides of which fall away when displacement is required.

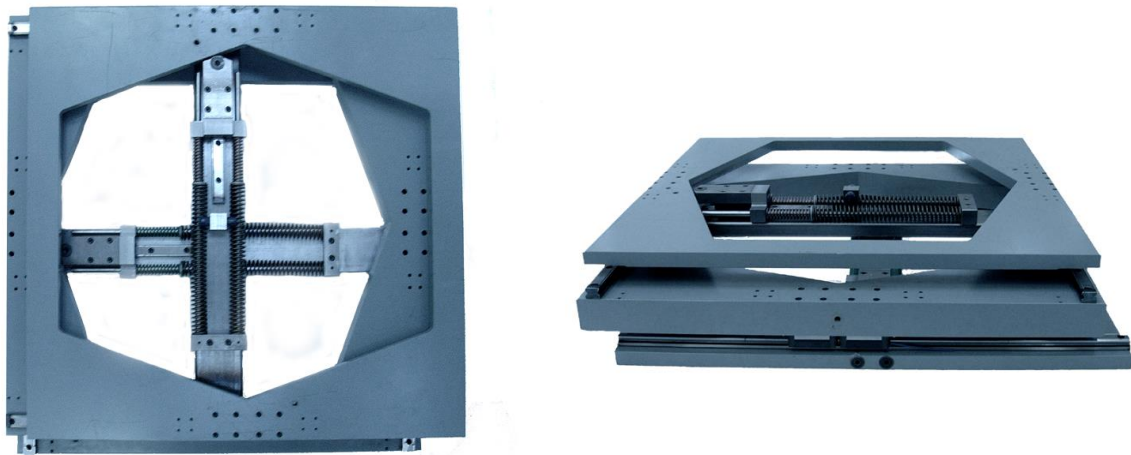

Figure 20: The Getty isolator design, top and side view.

The response of the system to ground motion is adjusted (by altering the spring rate) based on the object or object/furniture mass and the response spectra for the specific site or building.

In instances where there is a concern that the displacement capacity of the isolator is not sufficient and cannot be expanded, the spring sets are changed to a springs-in-series configuration. When the system reaches approximately 90% of its displacement capacity the softer of the two springs in series will have fully compressed and the stiffer spring will introduce increased stiffness to the system but still provide some degree of displacement. This configuration avoids impact should the displacement demands of the

seismic event surpass the capacity of the isolation mechanism. Further details of this approach can be found in Stavridis et al (2006) and Schoettler (2009).

Over the years the design has undergone a number of modifications, and testing has continued (Filiatrault 2001), including alteration of the shape of the ramp suggested by Prof. Vlasios Koumoussis of Athens Technical University. And work continues to reduce potential torsional loads at full displacements.

The isolator being used at the moment is estimated to have an efficiency of approximately 90% or more regarding the reduction of seismic forces. The efficiency of the isolators across the spectrum of ground motion input is determined by the available displacement. This in turn is directly related to the size of the isolation base, and this is an issue that often comes into conflict with aesthetic concerns of the designer. Using larger isolation platforms with large displacements for groups of objects is one way of assuring sufficient space for large displacements.

A drawback of highly efficient isolation systems relates to the ease at which the object/furniture assembly can be moved. To avoid unwanted displacement caused by the pedestal being pushed or accidentally bumped is the installation of surrounding barriers (beyond the extent of the maximum displacement area). But such barriers are unrealistic for exhibition showcases where proximity is a crucial consideration. And if a gallery has numerous isolation bases, paths through the gallery can become quickly obstructed by numerous barrier installations. To overcome this challenge the museum has developed an electromagnetic locking mechanism which is tripped by a P wave sensor. Such sensors are often used to shut off gas lines or elevators when P wave energy above a certain g force arrives at the site.

Furniture and fixtures: It must be remembered that when objects are attached to exhibition furniture, or held on shelves or in storage cabinets in the storage areas, these structures must also withstand the forces imposed by strong ground motion during earthquake events. In most cases it is beneficial to anchor exhibition pedestals to the floor unless their weight and base-to-height ratio assured a stable response. The material and manufacturing techniques used should keep in mind the forces that they will

experience. And it is wise to remember that attaching a heavy object to the top of a pedestal creates a single assembly with a high center of gravity unless the pedestal is heavily weighted or connected to the floor, in which case the structure of the supporting furniture should be robust.



Figure 21: Robust furniture construction with interior access and floor anchor device.

Conclusions: This general overview has illustrated some of the progress made in bringing seismic damage mitigation to museum collections. A range of effective methods is now available and, though they are in their nascent stages of development, they form a promising beginning towards reaching the goal of protecting the world's heritage treasures. Such a goal is not only consistent with the responsibilities of those charged with caring for collections but is at the very cutting edge of what has been termed *preventive conservation*.

But there remains a great deal more to be done, to be developed and to be understood. And there remain many minds to change and much support to gain for the fact that measures can be taken to reduce the damage and loss to collections due to earthquakes.

Around the world awareness must be raised of the hazard that earthquakes pose to cultural collections and further research as well as development of mitigation techniques are needed. Thorough documentation of damage within to collections due to earthquakes and the sharing of that information through appropriate

professional networks is essential. Above all however, open communication among those responsible for the preservation of cultural heritage internationally must include the topic of seismic hazards, irrespective of the long time frames between events. Figure 22 displays the dense concentration of earthquakes on and near tectonic boundaries, but we know that the ground shakes over large parts of our planet and with that movement comes the damage and loss of far too many of our cultural and historic treasures worldwide. It is incumbent on museums, whose mission of education and outreach also includes preservation and maintenance, and upon professional organizations and government to come together and develop a network of researchers and scientists, conservators and mount makers, designers and curators, directors and ministers to move this effort forward. Models for effective organization exist in many places and professions, especially in seismology and seismic engineering. These professions have benefitted from the realization that progress is greater when the efforts, the observations and the developments related to earthquake hazards and seismic damage mitigation are openly shared.

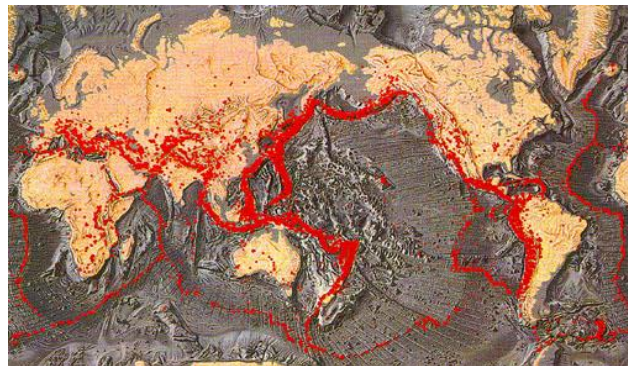

Figure 22

The author wishes to express gratitude to his Chinese colleagues Prof Weigou Yang and Prof Meng Wang for the opportunity to discuss these challenges with colleagues and friends in China and around the world. And he congratulates them and their sponsors for realizing this congress.

- Agbabian, M. S., S.F. Masri and R.L. Nigbor. *Evaluation of Seismic Mitigation Measures for Art Objects*. Los Angeles: Getty Conservation Institute, 1990.
- Applied Technology Council. *Proceedings of the Seminar on Seismic Design, Retrofit, and Performance of Nonstructural Components*, ATC-29-1. Redwood City, CA: Applied Technology Council, 1998.
- Bozorgnia, M., S.A. Mahinand, E. Brady. "Vertical Response of Twelve Structures Recorded During the Northridge Earthquake," *Journal of Earthquake Spectra* Vol. **14**, (1998): 411-432.
- Chong-Shien, Tsai. "Advanced Base Isolation Systems for Light Weight Equipment." In *Earthquake-Resistant Structures - Design, Assessment and Rehabilitation*, ed. Moustafa Abbas, 79-130. InTech, 2012.
- Earthquake Engineering Research Institute (EERI). "Loma Prieta Earthquake Reconnaissance Report," *Earthquake Spectra*, supplement to Volume 6 (May 1999).
- Filiatrault, Andre and Constantin Christopoulos. *Shake table tests of a base isolation table*. Report submitted to the J. Paul Getty Museum April 2001. Dept. of Structural Engineering, University of California San Diego, La Jolla, CA.
- Housner, George W. "The Behavior of Inverted Pendulum Structures During Earthquakes," *Bulletin of the Seismological Society of America* Vol. 53, No. 2, (1963):403-417.
- Hutchinson, Tara C., Derek Nastase, Falko Kuester, and Kai Doerr. "Vibration Studies of Nonstructural Components and Systems Within a Full-Scale Building," *Earthquake Spectra* Vol. 26, No. 2 (2010): 327-347. Ishyama, Y. "Criteria for Overturning of Rigid Bodies by Sinusoidal and Earthquake Excitations," *Proceedings of the 8th World Conference on Earthquake Engineering*, Vol. 4 (1984): 267-274.
- Kafle, B., N.T.K. Lam, E.F. Gad and J. Wilson. "Displacement Controlled Rocking Behavior of Rigid Objects," *Earthquake Engineering and Structural Dynamics* 40 (2011) 1653-1669.
- Milne, John. "Seismic Experiment," *Transaction of Seismological Society of Japan* **8**, (1885): 1-82.
- Podany, J. C. and P. Leavengood. "Chinese Monumental Sculpture: Treatment and Seismic Stabilization." In *Proceedings of the 7th International Congress on Deterioration and Conservation of Stone*. eds. Delgado Rodrigues, J., Fernando Henriques and F. Telmo Jeremias, 1517-1526. Portugal, International Institute for the Conservation of Historic and Artistic Works, 1992.
- Podany, J. C. "The Protection of Cultural Heritage in Museum Collections from Earthquake Damage." In *The Symposium on the Conservation and Preservation of the Cultural Artifacts*, ed. Cheng Shu-Min, 68-91. Taipei, Taiwan, Council for Cultural Affairs, 1996.
- Podany, J.C. (ed) *Advances in the Protection of Museum Collections from Earthquake Damage*. Los Angeles, California, J. Paul Getty Trust, 2008.
- Schoettler M. J. and A. Stavridis. "Seismic Base Isolation of *Zenobia in Chains* at the Huntington Library, Art Collections and Gardens." In *Seismic Mitigation for Museum Collections*, 189-195. Tokyo Japan, National Museum of Western Art, 2009.
- Stavridis, A., M. J. Schoettler, P.G. Somerville, H.K. Thio and J.C. Podany. "Design of a Self-Centering Base Isolator for an Antiquity." In *Proceedings 100th Anniversary Earthquake Conference Commemorating the 1906 San Francisco Earthquake*, San Francisco April 17, 2006. San Francisco, EERI, 2006.
- Somerville, P. G., N. F. Smith, R.W. Graves and N.A. Abrahamson. "Modification of Empirical Strong Ground Motion Attenuation Relations to Include the Amplitude and Duration Effects of Rupture Directivity," *Seismological Research Letters* 68 (1997): 199-222.
- Somerville, P. G. "Magnitude Scaling of the Near Fault Rupture Directivity Pulse," *Physics of the Earth and Interplanetary Interior* 137 (2003): 201-12.
- Stevenson Thomas. *Lighthouse Construction and Illumination*. London, E.F.N. Spon, 1881.

URS Corp. *Ground Motion Response Spectra and Time Histories*. Internal report Getty Museum Malibu. Los Angeles, URS, 2005.

Zhu, Z. Y. and T. T. Soong. "Toppling Fragility of Unrestrained Equipment," *Earthquake Spectra* Vol. 14, No. 4,(1998):695- 711.